

Svenska

Pyramid

Model: Dino Andreozzi © 1997.

Diagrams: Peter Budai © 1999.

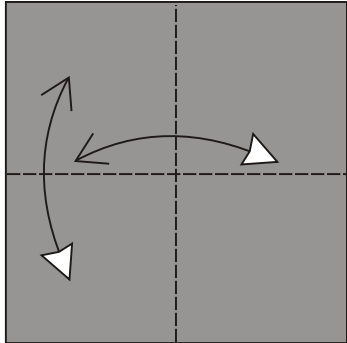
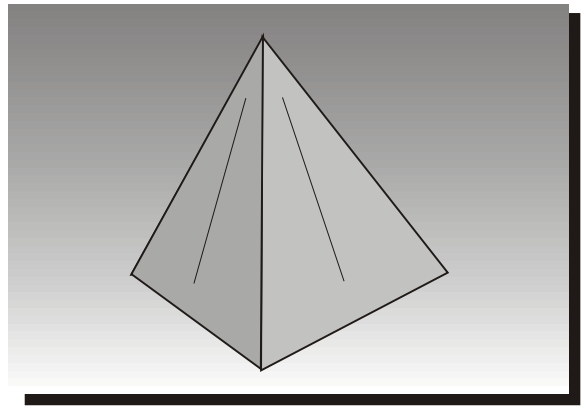

1. S  
Fold and unfold in half.  
Turn the paper over.

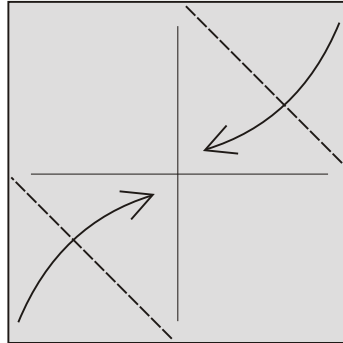

2. S  
Fold the two opposite  
corners to the center.

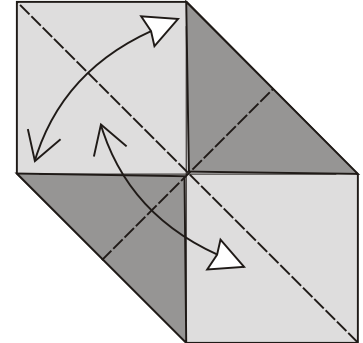

3. S  
Fold and unfold diagonally.

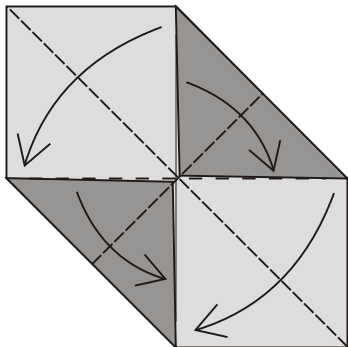

4. S  
Collapse the paper.

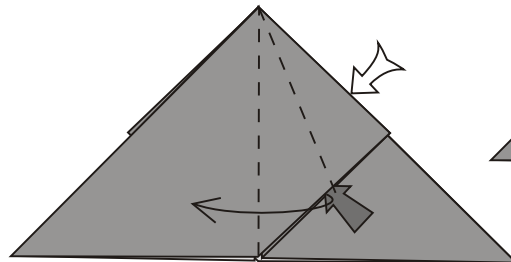

5. S  
Squash-fold.

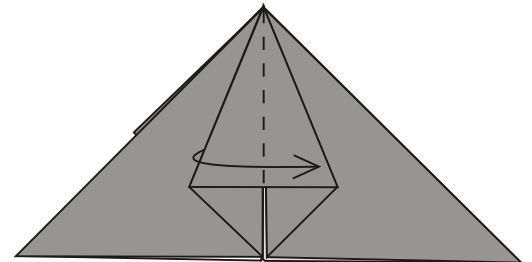

6. S  
Fold one layer to the right.

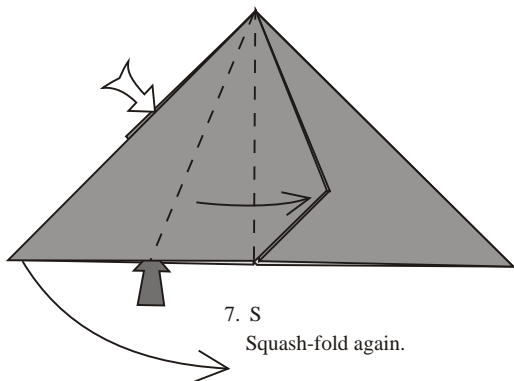

7. S  
Squash-fold again.

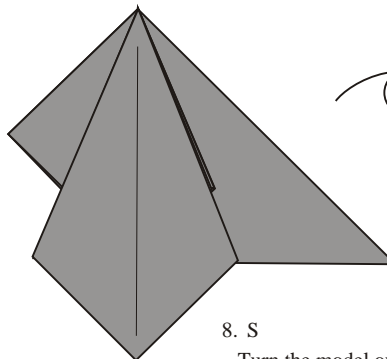

8. S  
Turn the model over.

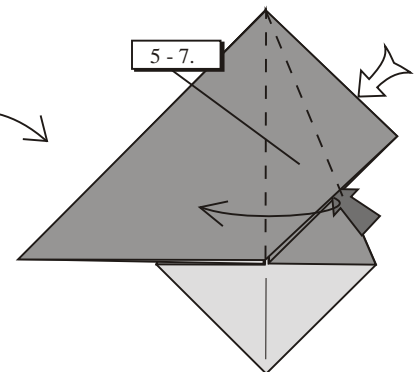

9. S  
Repeat steps 5-7.

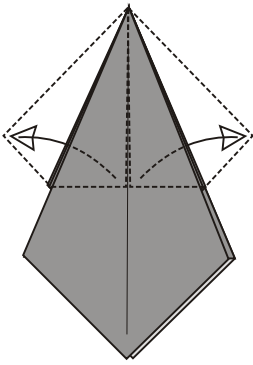

9. S  
Pull out central flaps.

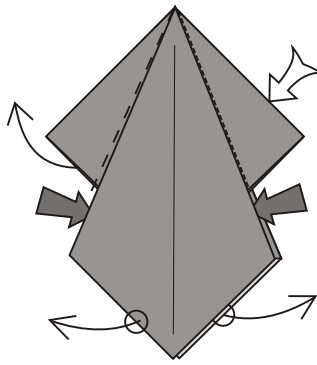

10. S  
Slide the long flaps apart.

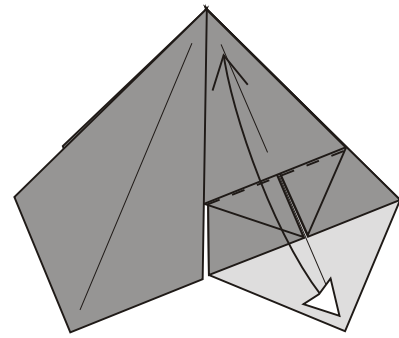

11. S  
Crease firmly through all layers.

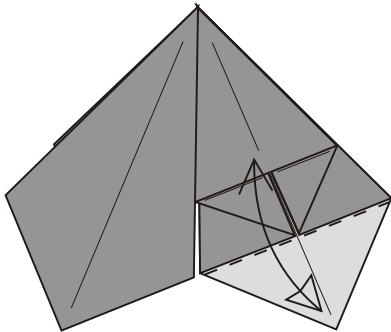

12. S  
Fold and unfold the corner.

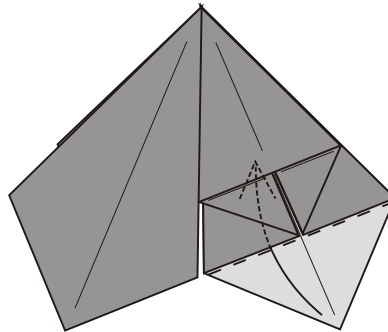

13. S  
Tuck the corner inside.

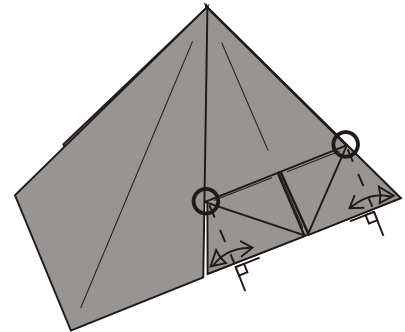

14. S  
Fold and unfold.

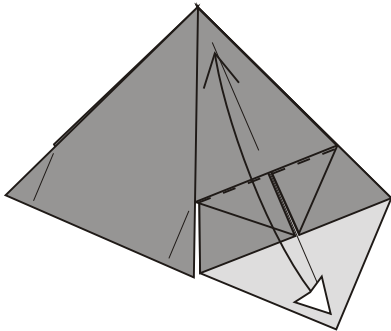

15. S  
Crease firmly again.

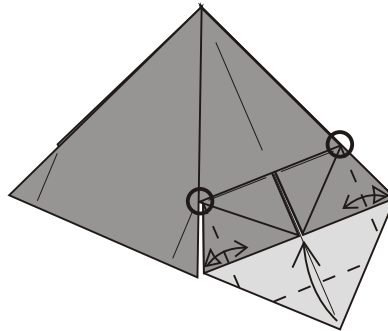

16. S  
Fold the corner up to the edge.  
Fold and unfold the sides.

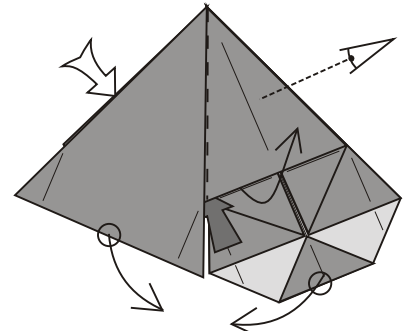

17. S  
Open up th model to be 3D.

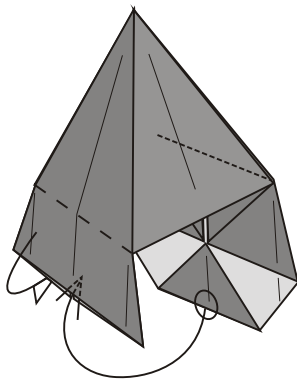

18. S  
Fold the flaps inwards while  
tucking them together.

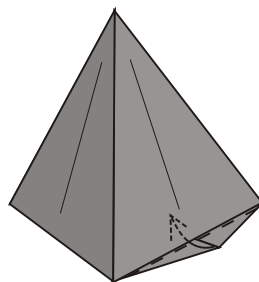

19. S  
Tuck the little flap inside. epeat behind.

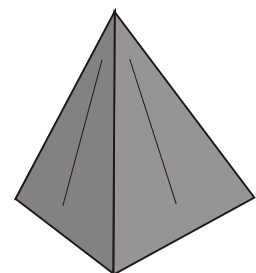

20. S  
Finished Pyramid.